



Contents

- [Introduction](#) 1
- [Example Diagrams.....](#) 2
- [Selecting an AFMS Controller \(with inclinometer\).....](#) 4
- [Selecting Flow Pickup Tubes.....](#) 5
- [Selecting Pressure Transducers](#) 6
- [Selecting the Mixed Air Temperature Sensor](#) 7
- [Selecting the Outside Air Temperature Sensor](#) 7
- [Selecting the Return Air Temperature Sensor](#) 7
- [Selecting a Proportional Actuator](#) 8
- [Selecting an HLO-1050 Linkage Kit.....](#) 8
- [Selecting Tools for Configuration and Operation.....](#) 9
- [Support](#) 9

Introduction

The KMC Airflow Measurement System (AFMS) reliably provides accurate outside, return, and supply airflow data for monitoring and control. The system delivers accurate, repeatable results on any type of equipment, without the traditionally expected mechanical limitations, performance issues, or ongoing maintenance issues.

The system consists of the following components, installed on an AHU, RTU, or unit ventilator:

- One AFMS controller with airflow measurement programming
- One inclinometer (included with the controller) mounted on a horizontal outside or return air damper blade
- If there are only vertical damper blades, one HLO-1050 Linkage Kit
- At least two airflow pickup tubes installed in a pitot array on the supply fan inlet, or in the supply air duct
- If a BAC-5901C(E)-AFMS is used, one pressure transducer
- If pressure assist measurements are needed (see **Considerations on page 4**), one additional pressure transducer, connected to two additional flow pickup tubes that are mounted on both sides of either the outside air damper or return air damper
- Three temperature sensors for outside, mixed, and return air
- One proportional actuator mounted on the damper shaft



Example Diagrams

Standard Application

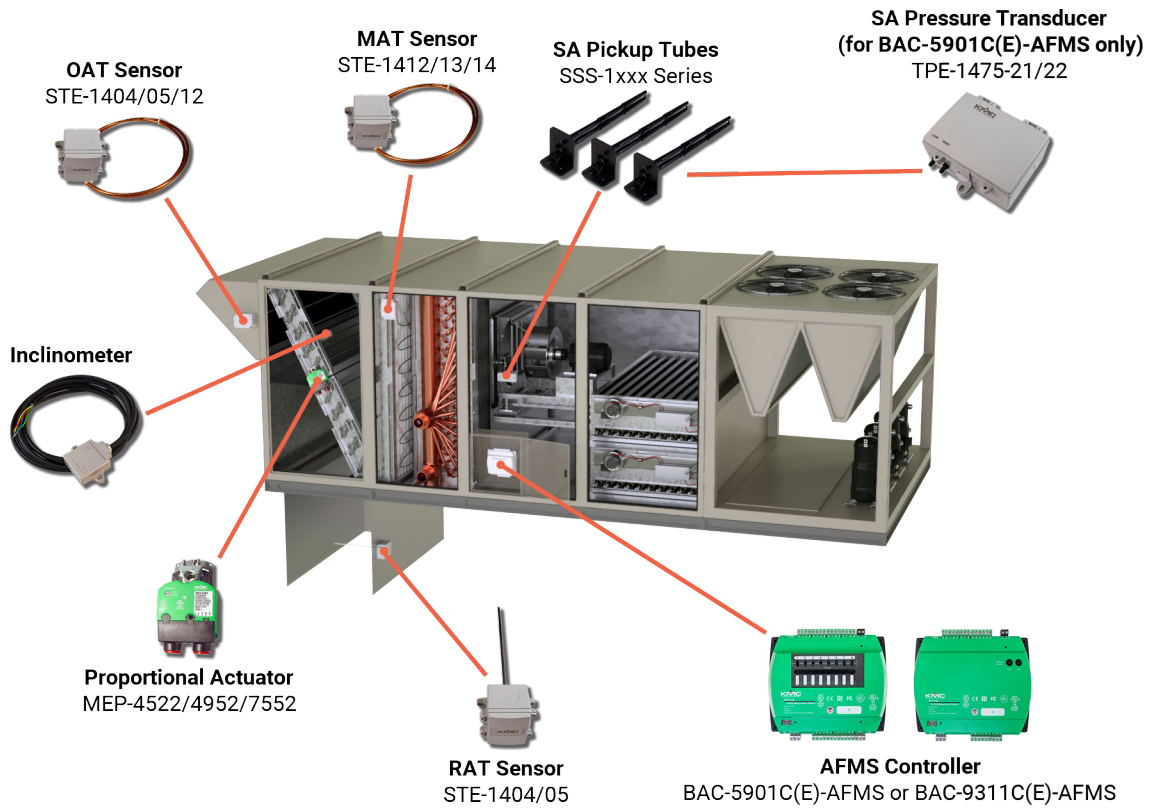

OAD (Outside Air Damper) PA (Pressure Assist) Application

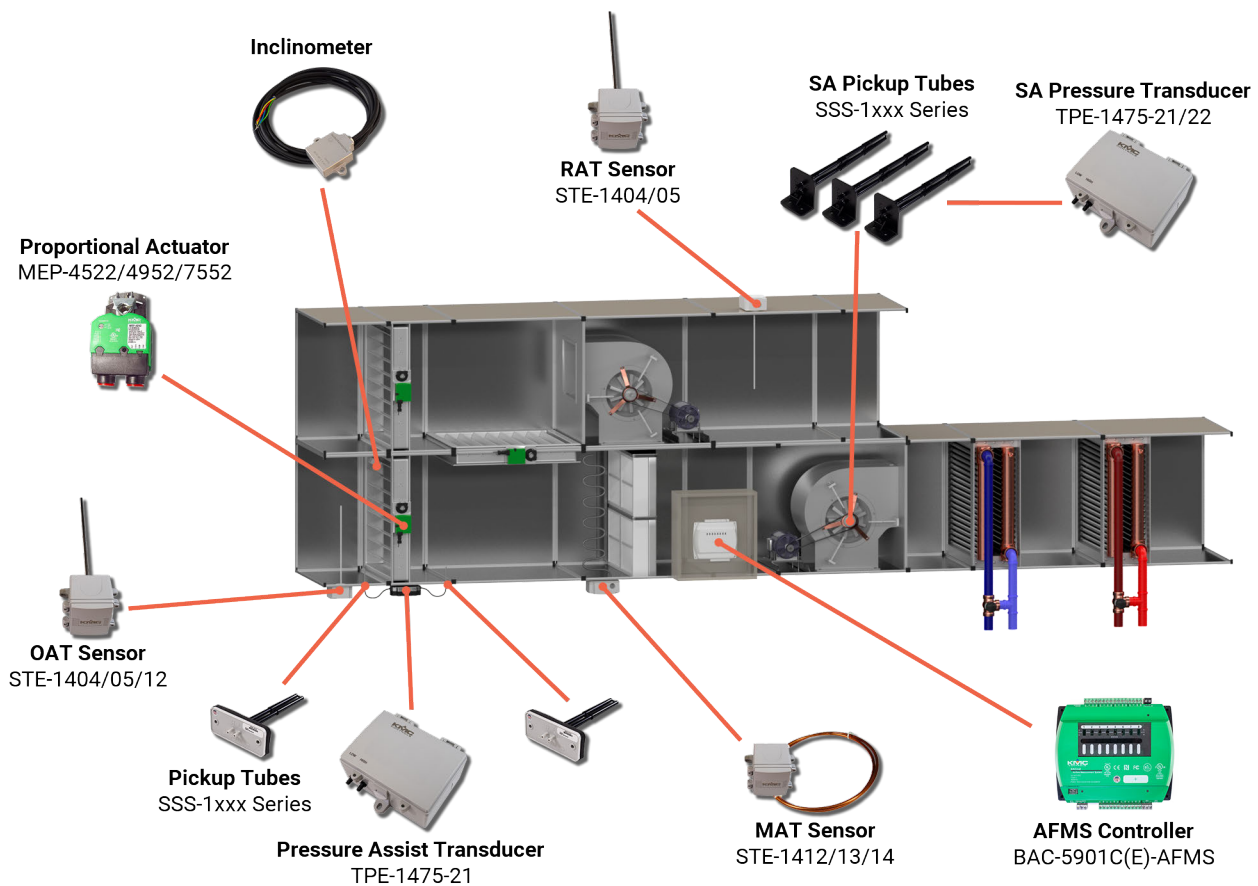

RAD (Return Air Damper) PA (Pressure Assist) Application

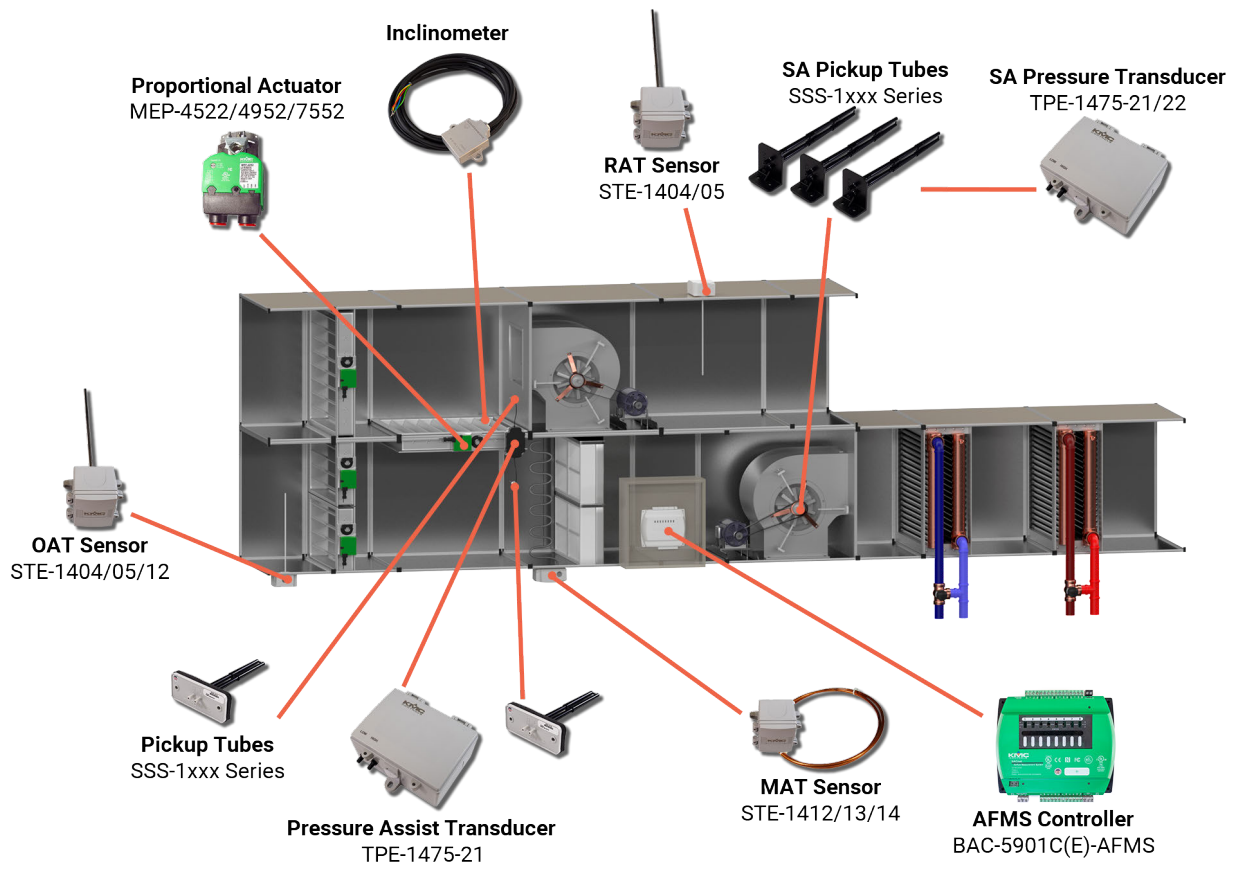

Selecting an AFMS Controller (with inclinometer)

Considerations

Does the unit have any of these non-standard features?

- A relief fan that is variable speed, or is operating independently of mixed air damper position
- A return fan that is not controlled by a supply fan / return fan offset
- A bypass damper utilized to bypass a heat recovery system
- Return VAV boxes
- Supply to return bypass (typically found in zone damper applications, or where a bypass damper is used in place of a VFD)
- Outside and return air dampers that modulate independently
- More than one outside air damper

If yes, the pressure of the unit's mixed and/or return air sections may change. In that case, select a BAC-5901C(E)-AFMS for (OAD or RAD) pressure assist measurements.

Are there plans to add custom programming?

If there are plans to add custom programming, select a BAC-5901C(E)-AFMS. If additional I/O are needed, select at least one [CAN-5900 Series I/O expansion module](#). (See the *Adding Custom Programming to a KMC AFMS* technical bulletin). KMC software is also required. (See [Selecting Tools for Configuration and Operation on page 9](#).)

Where will the controller be mounted?

If the controller will be mounted more than 20 feet from the location of the airflow pickup tubes (see [Selecting Flow Pickup Tubes on page 5](#)), select a BAC-5901C(E)-AFMS. A pressure transducer can be mounted closer to the pickup tubes, then wired over a greater distance to the controller. (See [Selecting Pressure Transducers on page 6](#).)



MODEL	APPLI-CATIONS	INPUTS	OUTPUTS	FEATURES				
				Customiz-able	Pressure Sensing	Real Time Clock (RTC)	Network	Airflow Measurement Programming
BAC-5901C-AFMS	RTU AHU unit venti-lator	10 total: • 2 analog (room sensor port) • 8 universal inputs (software configurable as analog, binary, or accumulator on terminals)	8 universal: • Software configurable as analog or binary • Override boards give additional options	✓	External	✓	MS/TP	standard airflow measurement, OAD pressure assist, and RAD pressure assist application programming
BAC-5901CE-AFMS							Ethernet	
BAC-9311C-AFMS		1 air pressure sensor and 8 (total) standard: • 2 analog (room sensor port) • 6 universal inputs (software configurable as analog, binary, or accumulator on terminals)	10 total: • 6 triacs (binary) • 4 universal (software configurable as analog or binary)		Integrated		MS/TP	standard airflow measurement application
BAC-9311CE-AFMS							Ethernet	

Selecting Flow Pickup Tubes

Options for Installation Location

The array of supply airflow pickup tubes can be installed in one of two places:

- At the supply air fan inlet
- At least six straight duct widths down the supply air duct

If pressure assist measurements are needed (see **Considerations on page 4**) two additional flow pickup tubes must be installed, one on either side of the outside air damper (for OAD pressure assist) or return air damper (for RAD pressure assist).

Arrangement in Parallel Array

The pickup points must be arranged in a parallel array that evenly covers the area of the supply air duct or fan inlet, similar to what is show below:

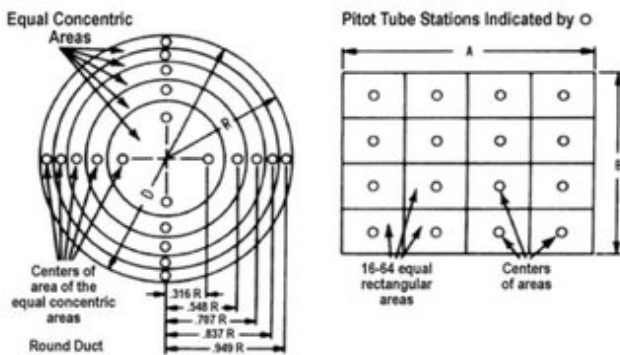

traverse on round and square duct areas

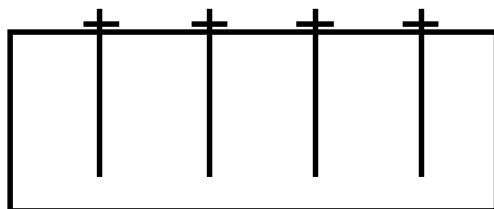

rectangular duct array

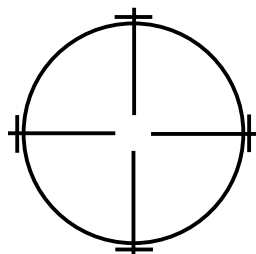

round duct array

Determining the Number of Pickup Points

1. Measure the duct or fan inlet:
 - For a rectangular or square duct, measure the length of the longest side.
 - For a circular duct or the supply fan inlet, measure the diameter.
2. Consult one of the tables below to determine the total minimum number of pickup points needed:

FOR A RECTANGULAR OR SQUARE DUCT	
If the longest side is less than or equal to:	Total minimum number of pickup points needed is:
4 inches	2
15 inches	3
24 inches	4
35 inches	5
48 inches	6
63 inches	7
80 inches	8
99 inches	9
100 inches or greater	10

FOR A CIRCULAR DUCT OR THE FAN INLET	
Duct diameter	Total minimum number of pickup points needed:
<10 inches	6
≥10 inches	10

Selecting the Tubes

Select multiple airflow pickup tubes (at least two) from below that are the maximum length that will fit in the space and total to at least the minimum number of pickup points needed:

SSS-101x models have 3/16" connections for 1/4" OD polyethylene tubing and flat mounting flanges for installation in ducts (or on fan inlets that have struts):

- SSS-1012** One pickup point, 80 mm (about 3") length tubes
- SSS-1013** Two pickup points, 137 mm (about 5.5") length tubes
- SSS-1014** Three pickup points, 195 mm (about 8") length tubes
- SSS-1015** Four pickup points, 252 mm (about 10") length tubes



SSS-111x models have 3/16" connections for 1/4" OD polyethylene tubing and right-angled mounting feet for installation on the supply air fan bell.

Single mounting foot:

- SSS-1112** One pickup point, 80 mm (about 3") length tubes
- SSS-1113** Two pickup points, 137 mm (about 5.5") length tubes
- SSS-1114** Three pickup points, 195 mm (about 8") length tubes

Dual mounting feet:

- SSS-1115** Four pickup points, five sections*, 315 mm (about 13") length tubes
- SSS-1116** Five pickup points, six sections*, 395 mm (about 15.5") length tubes
- SSS-1117** Six pickup points, seven sections*, 457 mm (about 18") length tubes

***NOTE:** The extra section connects the tubes to the second mounting foot, which mounts to the other end of the fan bell (or a midway strut).



Selecting Pressure Transducers

NOTE: Select pressure transducers for a BAC-5901C(E)-AFMS only. BAC-9311C(E)-AFMS have differential air pressure ports, so a pressure transducer is not necessary to connect the flow pickup tubes.

For the standard airflow measurement application, select one pressure transducer.

For airflow measurement applications with pressure assist, select two pressure transducers.

MODEL NUMBER	INPUT PRESSURE RANGES (SELECTABLE)
TPE-1475-21	-2 to +2" or 0 to 2" wc (-0.5 to +0.5 kPa or 0 to 0.5 kPa)
TPE-1475-22	-10 to +10" or 0 to 10" wc (-2.5 to +2.5 kPa or 0 to 2.5 kPa)



Selecting the Mixed Air Temperature Sensor

Averaging sensors are necessary to minimize errors due to stratification or poor airflow mixing in the mixed air chamber. It is recommended to install the largest averaging sensor that the equipment will accommodate. Copper sensors are recommended when the mixed air section is easily accessible. If not easily accessible, a cable sensor can be used.

MODEL	SENSOR TYPE	PROBE TYPE	PROBE LENGTH	ENCLOSURE	CONNECTIONS*
STE-1411	Duct, Averaging	Copper, bendable	6 feet (1.8 m)	Plastic, UL94-V0, IP65 (NEMA 4X) ABS	FT-6 plenum-rated, 22 AWG wire leads
STE-1412			12 feet (3.6 m)		
STE-1414			20 feet (6.1 m)		
STE-1413			24 feet (7.3 m)		
STE-1415		Flexible, FT-6 plenum-rated cable	6 feet (1.8 m)		
STE-1416			12 feet (3.6 m)		
STE-1417			24 feet (7.3 m)		

Selecting the Outside Air Temperature Sensor

For units with accessible outside air hoods, select an [STE-1412](#) 12-foot bendable copper averaging sensor.

For units with inaccessible outside air hoods, or for outside air ducts, select an [STE-1404](#) duct-mounted 12-inch probe with enclosure. (For sheltered tight fits, an [STE-1405](#) duct-mounted 4-inch probe without enclosure can be used.)

MODEL	SENSOR TYPE	PROBE TYPE	PROBE LENGTH	ENCLOSURE	CONNECTIONS
STE-1405	Duct, Rigid probe	1/4-inch OD stainless-steel	4 inches (100 mm)	None (mounting bracket only)	10-ft. FT-6 plenum-rated, 22 AWG cable
STE-1404			12 inches (300 mm)	Plastic, UL94-V0, IP65 (NEMA 4X) ABS	PVC insulated, 22 AWG, wire leads
STE-1412	OA Hoods, Averaging	Copper, bendable	12 feet (3.6 m)		

Selecting the Return Air Temperature Sensor

When possible, select an [STE-1404](#) duct-mounted 12-inch probe with enclosure. For sheltered tight fits, an [STE-1405](#) duct-mounted 4-inch probe without enclosure can be used.

MODEL	SENSOR TYPE	PROBE TYPE	PROBE LENGTH	ENCLOSURE	CONNECTIONS
STE-1405	Duct, Rigid probe	1/4-inch OD stainless-steel	4 inches (100 mm)	None (mounting bracket only)	10-ft. FT-6 plenum-rated, 22 AWG cable
STE-1404			12 inches (300 mm)	Plastic, UL94-V0, IP65 (NEMA 4X) ABS	PVC insulated, 22 AWG, wire leads

Selecting a Proportional Actuator

The unit must have a *proportional* damper actuator for the AFMS to modulate the damper as needed. If the unit does not have a proportional damper actuator already, select one.

MODEL	TORQUE* in-lb. (N•m)	PROPORTIONAL CONTROL	FEEDBACK	FAILSAFE
MEP-4552	45 (5)	0-10 or 2-10 VDC	0/1-5 or 0/2-10 VDC	✓
MEP-4952	90 (10)			
MEP-7552	180 (20)	0-10 VDC, 2-10 VDC, or 4-20 mA		

*Use the online [Actuator Calculator](#) to assist with torque requirements.



Selecting an HLO-1050 Linkage Kit

The AFMS controller's inclinometer must be mounted on a *horizontal-axis* damper blade. For units with *vertical-axis* damper blades, select an **HLO-1050 Linkage Kit**. The linkages transfer the damper motion to a surface with a horizontal axis (the kit's inclinometer crankarm), on which the inclinometer can then be mounted.

The kit's damper blade crankarm can be mounted to a damper blade or on a jackshaft using the included jackshaft coupler and V-bolt.

If the kit's axle mount shaft cannot be mounted on a unit's damper frame (such as when mounting in a duct), select a **VTD-0903** right-angle bracket in addition to the kit.

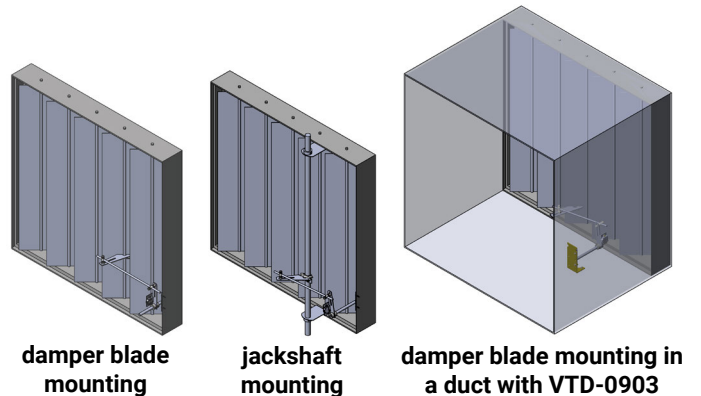

Selecting Tools for Configuration and Operation

The rows in the table below list the processes to set up and operate an AFMS. The columns present the KMC Controls tools that can be used to complete the processes. Consult the table to determine which tools can complete each process and for which AFMS applications.

The user interface and setup requirements of each tool varies. For more information, see each tool's product pages and documents.

PROCESSES	CONFIGURATION TOOLS						
	BAC-5051(A)E router	Ethernet controller ¹ served web pages	Conquest™ NetSensor	KMC Connect™ or TotalControl™	KMC Converge™ for Niagara Workbench	KMC Commander® ²	KMC Connect Lite™ (NFC) app ³
Selecting the application		✓	✓	✓			
Configuring communication		✓	✓	✓	✓		✓
Setting AFMS parameters	✓	✓	✓	✓	✓	✓	
Calibrating sensors	✓	✓	✓	✓	✓	✓	
Starting Learning Mode	✓	✓	✓	✓	✓	✓	
Controlling airflow	✓	✓	✓	✓	✓	✓	
Monitoring operation & faults	✓	✓	✓	✓	✓	✓	
Adding custom programming ⁴				✓	✓		

¹ Ethernet "E" models with the latest firmware can be configured with a web browser from pages served within the controller.
² KMC Commander's AFMS module currently supports the standard AFMS application only.
³ Near Field Communication via enabled smart phone or tablet running the KMC Connect Lite app.
⁴ Requires a BAC-5901C(E) -AFMS and at least one **CAN-5900 Series** I/O expansion module. (See **Considerations on page 4.**)

Support

Additional resources for product specifications, installation, configuration, application, operation, programming, upgrading and much more are available on the KMC Controls web site (www.kmcccontrols.com). Log in to see all available files.

